

Data Sheet



Article number: 339711190000

Description: Multibeam 6 Coupling 711.19.0000
Acetal & clamp hubs

Measures

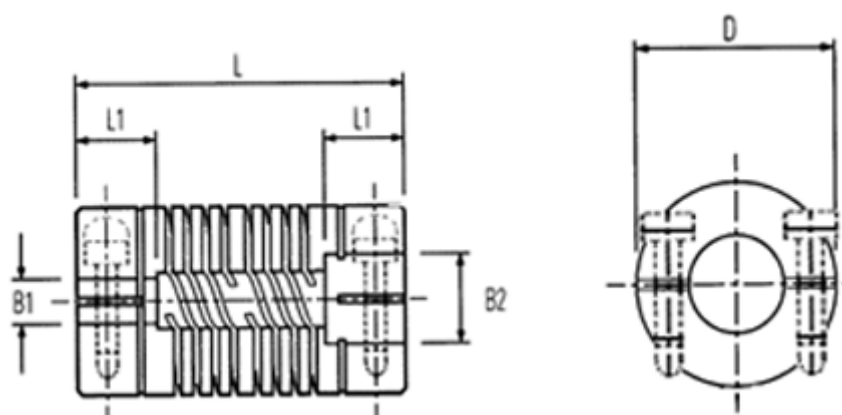

B2: Pre-drilled	= 4.0
B2: Pre-drilled	= 6.35
Cap screw	= M2,5
D	= 19.1
L	= 26.5
L1	= 6.5
Max angular displacement	= 0.25
Max B1 & B2	= 9.53

Max parallel displacement	= 7
Peak Torque NM	= 1.30